

# HM-TP96-Q/W-SP60-L50

## Handheld Thermography Camera



The HIKMICRO SP60 high-performance handheld thermal imaging camera is ideal for industrial, predictive, oil and gas, and utility maintenance inspections.

HIKMICRO SP60 has a high sensitivity (NETD < 30 mK) and high resolution (640 × 480) HIKMICRO VOx detector, and the temperature calibration is up to 650°C. This flexible and ergonomic thermal imager provides an electronic viewfinder and a 180° rotating lens, making long-day outdoor inspections easier. Advanced features help thermal imaging professionals to easily survey equipment and find signs of malfunction, such as GPS and compass annotations, continuous digital zoom, and 1-Tap level and span.

Connect HIKMICRO Viewer App or HIKMICRO Analyzer software to transfer, analyze, and share pictures, and generate reports for free.

### Key Features

- Thermal resolution: 640 × 480 (307,200 pixels), NETD: < 30 mK (@ 25°C, F# = 1.0)
- Temperature measurement range: -20°C to 650°C (-4°F to 1202°F)
- Accuracy: Max. (± 2°C/3.6°F, ± 2%)
- The 90° rotating screen and the 180° rotating lens design
- 1024 × 768 OLED electronic viewfinder and auto-brightness 5-inch color LCD display
- 1.x to 12.x continuous digital zoom
- Manual, automatic, and 1-Tap level and span
- Manual focus, continuous autofocus, autofocus, and laser-assisted focus
- GPS, BDS, GLONASS or GALILEO & compass annotation functions
- 25 Hz image frequency
- 8 MP optical camera
- Up to 4 hours continuous running

## Specification

<b>Thermal Module</b>	
Detector Type	Vanadium Oxide Uncooled Focal Plane Array
IR Resolution	640 × 480 (307, 200 pixels)
Detector Pitch	17 μm
Spectral Range	8 to 14 μm
NETD	< 0.03°C (30 mK) at 25°C (77°F) ambient temperature, F# = 1.0
FOV (Field of View)	50.0° H × 37.3° V
Image Frequency	25 Hz
Focal Length	12.6 mm
Focus	Continuous Autofocus/Autofocus/Manual Focus/Laser Assisted Focus
Focus Speed	Approx. 1 second
Minimum Focus Distance	0.2 m
Interchangeable Lens Options	Yes
Lens Recognition	Automatic
IFOV (Spatial Resolution)	1.35 mrad
F-number	F1.0
<b>Optical Module</b>	
Built-in Visual Camera	3264 × 2448 (8 MP)
Focus	Fixed
FOV	65° H × 51° V
Picture Resolution	Configurable: 2 MP, 5 MP, 8 MP
Video Resolution	900 × 720
<b>Image Display</b>	
Display	1280 × 720 Resolution, 5" LCD Touch Screen
Screen Brightness	Manual/Automatically adjust
Lens Rotation	180°
Display Rotation	90°
Viewfinder	Built-in 1024 × 768 pixels
Digital Zoom	1.x to 12.x continuous
Color Palettes	7: White Hot, Black Hot, Rainbow, Ironbow, Red Hot, Fusion, Rain
Image Modes	Thermal/Optical/Fusion/PIP
PIP	Resizable and movable infrared area on the visual image

Fusion	Thermal image with visual camera details
Level/Span	Auto/Manual/1-Tap Touch-Screen
<b>Measurement and Analysis</b>	
Object Temperature Range	-20°C to 650°C (-4°F to 1202°F)
Accuracy	Max. ( $\pm 2^{\circ}\text{C}/3.6^{\circ}\text{F}$ , $\pm 2\%$ )
Measurement Presets	Center Spot, Hot Spot, Cold Spot, Off
User-defined Measurement Points	10 points
User-defined Measurement Lines	1 line with Max./Min./Avg. temperature
User-defined Measurement Areas	3 areas with Max./Min./Avg. temperature
High Temperature Alarm	Audible/visual alarm of above temperature threshold, User-defined temperature threshold
On-Camera Emissivity Correction	Variable from 0.01 to 1.0 or selected from the materials list
On-Camera Reflected Temperature Compensation	Automatic, based on the input of the reflected temperature
On-Camera Transmission Correction	Automatic, based on the inputs for distance and humidity
<b>Data Storage</b>	
Storage Media	Default Storage: Removable Card (64 GB); Max. Storage Capacity: 128 GB
Image Storage Capacity	Approx. 60,000 images (The size of a single image is about 900 KB to 1.3 MB)
Image File Format	Radiometric image with measurement data included JPEG image without measurement data included
Voice Note	Max. 60 seconds
Text Note	Max. 200 characters
Video Storage Capacity	Approx. 64 h (The size of a one-minute video is about 15 MB to 20 MB)
Video File Format	Standard MP4 non-radiometric video
<b>software</b>	
PC Software	HIKMICRO Analyzer
APP	HIKMICRO Viewer App
Cast Screen	UVC Alarm Client
<b>Battery</b>	
Power Supply	12 VDC/3 A, 5 VDC/3 A (Charging via USB), fast charging
Battery Type	Dismountable and rechargeable Li-ion battery
Battery Operating Time	4 hours continuous running per battery (actual life varies depending on settings and usage)
Battery Charging Time	2.5 h to full charge

Battery Charging System	Two-bay battery charger or in-imager charging, fast charging
AC Operation	AC operation with included power supply (100 VAC to 240 VAC, 50/60 Hz)
<b>General</b>	
Wi-Fi	802.11 b/g/n (2.4 GHz+5 GHz)
Bluetooth	Bluetooth 4.2
USB Interface	USB Type-C
HDMI Interface	HDMI-D
SD Card Interface	64 GB SD card
LED Light (torch)	Yes
Laser Pointer	Yes
Laser Distance Meter	Indoor distance: 50 m (164 ft); Outdoor distance: 10 m (33 ft).
Laser Type	Class II, Wavelength: 635 nm; Power: < 1 mW
Geolocation	Location data automatically added to every image from the built-in GPS, BDS, GLONASS or GALILEO
Compass	Camera direction automatically added to every image
Carrying Case	Yes
Protection Level	IP54 (protected against dust, limited ingress; protection against water spray from all directions)
Warranty	3 years for whole product, 10 years for detector, and 2 years for battery
Recommended Calibration Cycle	1 year (assumes normal operation and normal aging)
Safety	IEC 61010-1: Overvoltage Category II, Pollution Degree 2
Electromagnetic Compatibility	EN55032: 2015 + A11: 2020 EN50130-4: 2011 + A1: 2014 EN61000-3-3: 2013
Australian RCM	EN 61010-1: 2010 EN55032: 2015 + A11: 2020 EN50130-4: 2011 + A1: 2014 EN61000-3-3: 2013
RoHS Compliant	Yes
Vibration	0.03 g <sup>2</sup> /Hz (3.8 g), 2.5 g IEC 60068-2-6
Shock	25 g, IEC 68-2-29
Working Temperature Range	-20°C to 50°C ( -4°F to 122 °F)
Storage Temperature Range	-20°C to 60°C ( -4°F to 140°F)
Relative Humidity	< 95% non-condensing
Weight	Approx. 1590 g (3.51 lb)
Dimension	204.7 mm × 149.7 mm × 87.8 mm (8.06" × 5.89" × 3.46")
Tripod Mounting	UNC ¼"-20

Language	21 Languages
Language	English, German, French, Spanish (Spain), Portuguese (Portugal), Italian, Czech, Slovak, Polish, Hungarian, Romanian, Dutch, Danish, Norwegian, Finnish, Swedish, Russian, Turkish, Japanese, Korean, Chinese (Traditional)

## Available Model

**HM-TP96-Q/W-SP60-L50**

## Dimension

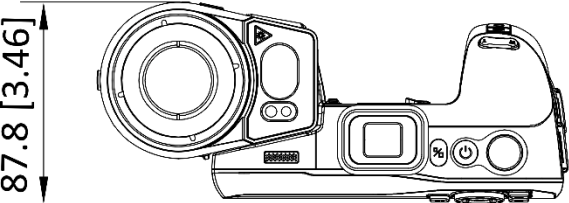
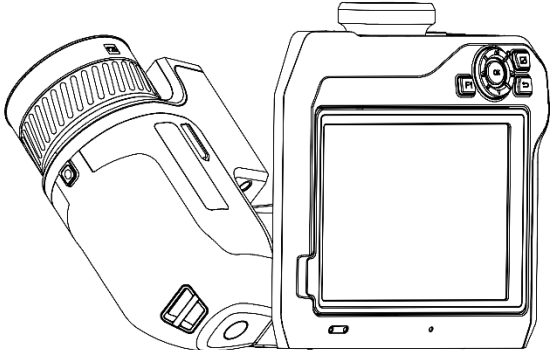
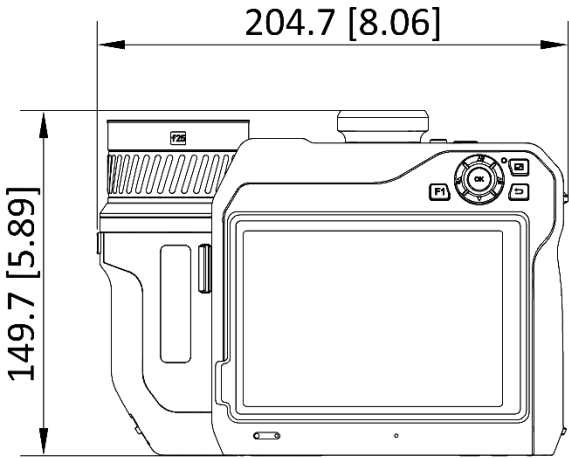

Unit: mm [inch]

## Packing List

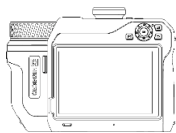

Camera (× 1)



L50 Lens (× 1)

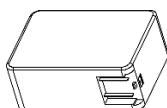

Power Adapter (× 1)

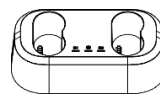

Charging Base (× 1)

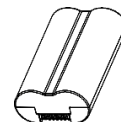

Battery (× 2)



USB Cable (× 1)



HDMI Cable (× 1)



Hand Strap (× 1)



Neck Strap (× 1)

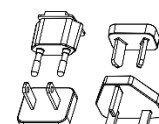

Adapter Plugs (US,  
UK, EU, AU)



Dustproof Cover (×  
1)

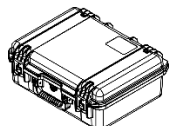

Carrying Case (× 1)

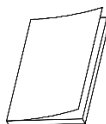

Quick Start Guide (× 1)

**COMPLIANCE NOTICE:** The thermal series products might be subject to export controls in various countries or regions, including without limitation, the United States, European Union, United Kingdom and/or other member countries of the Wassenaar Arrangement. Please consult your professional legal or compliance expert or local government authorities for any necessary export license requirements if you intend to transfer, export, re-export the thermal series products between different countries.



 HIKMICRO Thermography  hikmicro\_thermography  HIKMICRO Thermography  HIKMICRO  [info@hikmicrotech.com](mailto:info@hikmicrotech.com)  <http://hikmicrotech.com/en>

room 313, unit B, building 2, 399 danfeng road, xixing subdistrict, binjiang district, hangzhou, zhejiang  
@hangzhou microimage software co., Ltd .2020 | data subject to change without notice!